

# **The functional category D in a language without determiners: The case of Igbo**

Greg Obiamalu

*Igbo has no definite and indefinite articles. Progovac (1995) is of the view that articles are the only true determiners. Igbo has some other nominal modifiers such as demonstrative, quantifier, numeral, adjective, pronominal modifier which in most cases occur as post modifiers. Adopting the DP-hypothesis which assumes that the argument phrase is headed by a functional category D which takes an NP as its complement, we argue that, in Igbo, the D head position remains null and bare nominals are allowed. The only element that could occupy the D head position is a linker, òkè which could be found in the genitive construction and in virtually all types of Igbo nominal constructions.*

**Keywords:** *Igbo, determiner, functional category*

## **1. Introduction**

Determiner (abbreviated to Det in earlier works and to D in more recent works) is a functional element or functor which is defined by Radford (1997: 447) as ‘a word which is typically used to modify a noun, but which has no descriptive content of its own’. Determiner is a traditional notion used to refer to nominal modifiers such as articles, demonstratives, quantifiers, etc, that determine the referential or quantificational properties of the nouns associated with them. If we assume determiners to be functional categories, then they should have the characteristics that define functional categories which include among others

- lack of descriptive content
- limited in number (closed class )
- morphological dependency (affixes, clitics )
- sometimes null (empty category)

It is important to note that sometimes certain functional categories appear as independent lexical items. Determiner seems to belong to this group. In some languages, it exists in the form of an independent lexical item, in some, it appears in the form of an affix attached to the noun and yet in many other languages, it appears as a null constituent of the nominal phrase. To this last group belongs Igbo. We shall demonstrate in this paper that Igbo lacks determiner as it exists in languages like English, but yet projects a determiner phrase (henceforth DP) which is headed by a null category or by a special link item ‘nke’ which optionally occurs in all types of Igbo nominal expressions.

## **2. Defining the Igbo determiner**

Progovac (1995) is of the view that, articles such as the English ‘the’ and ‘a’ are the only elements that could be said to be true determiners. In line with Progovac’s view, Adger (2003) identifies determiners in English as elements that are in complementary distribution with the definite article ‘the’. These elements include the indefinite article ‘a’,

demonstratives: this, that, and quantifiers: all, every, etc. These elements do not co-occur with ‘the’ as demonstrated by the ungrammaticality of (1a-c)

- (1) a. \*the a teacher  
b. \*that the book  
c. \*the every book

The fact, that these other modifiers do not co-occur with the articles led to the classification of all such nominal pre-modifiers as determiners in English.

Igbo has no definite or indefinite articles. However, these other nominal modifiers: demonstrative, quantifier, adjective exist in Igbo. The question is, do they qualify to be called determiners in Igbo? Mbah (2006: 112) agrees that “Igbo language does not have determiners as it is used in the Indo-European languages in association with common nouns”. He rather prefers to use the term ‘determiner’ to refer to any category in Igbo “which qualifies, modifies or quantifies a head so as to discriminate it from other hitherto identical lexical items”. Going by Mbah’s definition of Igbo determiners, all nominal modifiers, including adjectives, relative clauses, possessive NPs are all determiners. We disagree with Mbah on this non-technical use of determiner for two reasons. One, determiners are functional categories and functional categories generally lack descriptive content. Adjectives, possessive NPs and relative clauses do not lack descriptive or thematic content and therefore do not qualify as functional categories in Igbo. Two, if we take all Igbo nominal modifiers to be determiners, then, there is no node in the phrase that could be seen as dominating and c-commanding all the other nodes within the nominal phrase since many of them, unlike the English determiners can co-occur. Consider (2) below

- (2) *ulò ahụ niilē buru ibū*  
house Dem Q RC  
‘all those houses that are big

If we take (Dem)onstrative, (Q)uantifier and R(elative) C(lause) to be determiners, then (2) will be a case of a nominal construction with multiple determiners, which is undesirable from a theoretical perspective .

Our position here is that Igbo generally lacks an overt determiner which most times spells out overtly as tonal prosody (genitive and associative tone pattern) or as *ñkè* which is a functional word that could optionally occur in any type of Igbo nominal construction and in complementary distribution with genitive tone pattern. The modifiers project separate functional or lexical categories such as DemP, QP, AP etc). Our position hinges on the DP-Hypothesis.

### 3. The DP hypothesis

In recent theoretical analysis of the nominal phrase, it has been argued that the noun is not the head of the argument nominal phrase traditionally referred to as the Noun Phrase (NP). It is rather argued that the determiner is the head of the phrase. This idea was first proposed by Abney (1987) and came to be known as the DP- hypothesis (cf Abney 1987, Szabolcsi 1987, Longobardi 2004).

Abney (1987) gives some theoretical as well as empirical reasons why the functional category D, rather than the lexical category N, should be seen as the head of the argument nominal phrase. This is comparable to the earlier analysis where the predicate is assumed to be headed by a functional category I (inflection) which takes a VP as its complement (Chomsky 1986). The DP-hypothesis assumes a nominal phrase to have the structure below.

(3)

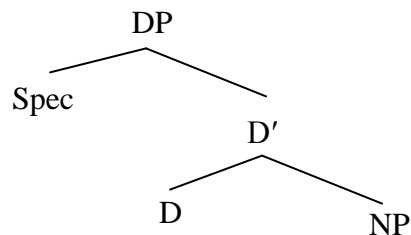

(3) implies that the D head takes an NP as its complement as well as making provision for a specifier position that could house some other elements such as a possessor argument DP.

On theoretical grounds, Abney (1987) argues that the assumption that the determiner occupies the Spec NP position is inconsistent with the X-bar principle and a violation of the Modifier Maximality Constraint (MMC), which states that “every non-headed term in the expansion of a rule must itself be a maximal projection of some category” Stowell (1981: 70). The determiner in the NP-analysis is neither seen as a maximal projection nor the head of the containing maximal projection, NP.

Another argument given by Abney (1987) in support of the DP-hypothesis is that in some languages, for example, English, there is a parallel between the structure of sentences and that of nominal phrases as shown in (4).

- (4) a. [<sub>S</sub> John bought a car]  
 b. [<sub>NP</sub> John’s buying a car] caused his downfall

The S constituent in (4a) has the same structure as the NP constituent in (4b). Both have subject, verb and object. The predicator is the verb ‘buy’ which is inflected for tense in the sentence (4a), but takes the ‘-ing’ tenseless suffix in the nominal phrase of (4b). The only difference is that the subject takes a genitive clitic ‘s’ within the noun phrase but not in the sentence. The argument here is that just as the functional category I is the mediator between the subject and the VP, where tense and agreement features are located, D is a similar functional category within the nominal phrase. In (4b), the genitive marker ‘s’ is a D which mediates between the subject, ‘John’ and the VP, ‘buying a car’. The NP constituent in (4b) is represented in the phrase-marker (5)

(5)

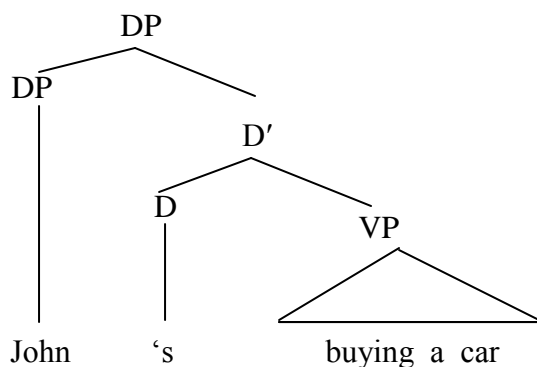

The DP ‘John’ is the subject of the higher DP which is headed by the genitive marker ‘s’ and takes the VP, ‘buying a car’ as its complement.

That some languages exhibit some kind of agreement between the possessor and the possessed (technically referred to as possessum) provides further argument in support of the DP-hypothesis. The examples below, from Hungarian, taken from Szabolcsi (1987:20), illustrate the point.

- (6) a. *az en kalap-om*  
 the 1.NOM hat-1Sg  
 ‘my hat’
- b. *a te kalap-od*  
 the 2.NOM hat-2Sg  
 ‘your hat’
- c. *a Peter kalap-ja*  
 the Peter hat-3Sg  
 ‘Peter’s hat’

The NP *kalap* takes different agreement suffixes depending on the possessor NP. Such an agreement relationship can only be licensed by a functional category. The affixes are instances of the functional category D in the Hungarian data in (6).

The DP-hypothesis provides a better framework for the analysis of the pronoun which is obscured under the NP-analysis. Pronouns are used in place of nouns. Most personal pronouns overtly show the phi-features (number, person and gender) normally associated with agreement. Obviously, pronouns are functional categories. In English, Radford (2004:44) refers to pronouns as ‘pronominal determiners’, while he refers to the articles, demonstratives and quantifiers as ‘prenominal determiners’

Adopting the DP-hypothesis, simple nominal phrases such as ‘the book’ will be re-analysed as in (7)

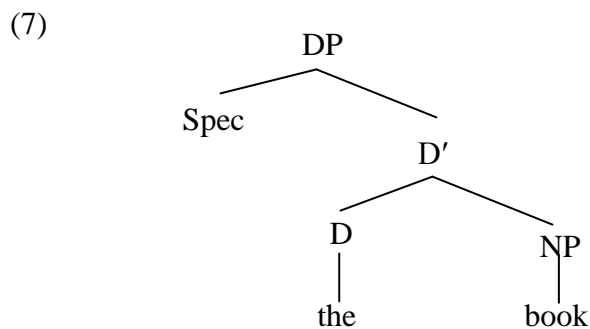

In English, ‘the’ could be replaced with some other elements such as ‘a’ ‘that’ ‘this’ ‘those’ ‘these’ ‘every’ etc. Their co-occurrence with ‘the’ is barred and this could explain why they are all classified as determiners in English. However, there are languages where these items could co-occur with the article such as in Hungarian, Javanese and Italian (taken from Progovac, 1995:82)

- (8) a. *ez a haz* (Hungarian)  
this the house  
'this house'
- b. *ika n anak* (Javanese)  
this the boy  
'this boy'
- c. *la mia penna* (Italian)  
the my pen  
'my pen'

The co-occurrence of the article with other elements like demonstratives, possessives, etc in many unrelated languages led Gusti (1992) to conclude that they occupy specifier positions, not head of DP. Going by the MMC (Stowell 1981), every modifier whether specifier or complement is a separate maximal projection. Gusti's idea gave rise to more functional projections within the nominal phrase: DemP, PossP, QP, NumP etc.

This brings up the question, whether languages like Igbo, where no article exists, project a DP as well as these other functional categories? We will demonstrate in this study that in addition to the functional category Dem, Gen and Q in Igbo, there is a functional category D which is higher up in the structure, c-commands and has scopal authority over the NP and the other functional categories within the phrase. This functional category D may appear null (Overtly marked by just tone pattern) or occupied by a lexical element *̀nkè* which optionally occurs with any of the other functional elements. Before we move on to show how the Igbo nominal phrase is syntactically structured, let us look briefly at the possible constituents of an Igbo nominal phrase.

#### 4. The constituents of the Igbo nominal phrase

Elements of different categories could be found within an Igbo nominal phrase. These elements co-occur with some degree of flexibility in the word order that co-relates with slight meaning differences or no difference at all. The examples in (9a&b) are acceptable structures in Igbo.

- (9) a. *̀lò ahụ dum*  
house Dem Q  
'all those houses'
- b. *̀lò dum ahụ*  
house Q Dem  
'all those houses'

(9a&b) show that a demonstrative and a quantifier can exchange position without bringing about change in meaning. Emenanjo (1978: 80) gives a rough schematic representation of the structure of a simple<sup>1</sup> nominal phrase showing all the possible constituents.

$$(10) \quad \underbrace{\pm A \left\{ \begin{array}{l} N \\ \text{Head} \end{array} \right\}}_{\text{Head}} \underbrace{\pm A \pm P \pm Nm \pm Q \pm D \pm Q}_{\text{Central}} \left\{ \begin{array}{l} \text{RC} \end{array} \right\}$$

Note:  $\pm$  = Optional  
 $+$  = Obligatory  
A = Adjective  
N = Noun  
P = Pronominal Modifier  
Nm = Numeral  
Q = Quantifier  
D = Demonstrative  
RC = Relative Clause

What Emenanjo is trying to show in (10) is that the Igbo nominal phrase could contain different types of categories which are optional and do co-occur. As expected, the only obligatory constituent is the Noun which is assumed to be the head of the phrase. (11) below is an illustrative phrase where all the constituents in (10) are present.

$$(11) \quad \text{aj}\bar{o} \text{ akw}\bar{a} \text{ ocha } \bar{a}ny\bar{i} \text{ at}\bar{o} \text{ niil}\bar{e} \text{ ah}\bar{u} \text{ furu } \bar{e}f\bar{u}^2$$

A N A P Nm Q D RC

‘all those three bad white clothes of ours that are missing’

(11) shows that different types of modifiers can co-occur in the same NP. All modifiers, except the adjectives, *ajō* ‘bad’, some adjectival nouns like *ogologo*, *obele*, etc, and the numeral *otù* ‘one’ occur after the noun. The exceptions allude to an interesting generalization for word order as we shall see in the next section.

### 5. Functional heads, word order and the directionality parameter within the Igbo nominal phrase

If we adopt the DP-hypothesis for Igbo, which assumes that the argument nominal phrase is headed by a functional element, the structures where the noun comes before the functional element present a problem for a theory that assumes the functional head to be higher in the structure and have scope over the NP which it c-commands. Consider the phrases below.

$$(12) \quad \begin{array}{ll} \text{a. } \text{ul}\bar{o} \text{ niil}\bar{e} & \text{c. } \text{nwok}\bar{e} \text{ ah}\bar{u} \\ \text{house Q} & \text{man Dem} \\ \text{‘all houses’} & \text{‘that man’} \end{array}$$

$$\begin{array}{ll} \text{b. } \text{mmad}\bar{u} \text{ dum}\bar{e} & \text{d. } \text{o}\bar{k}e \text{ à} \\ \text{person Q} & \text{rat Dem} \\ \text{‘everybody’} & \text{‘this rat’} \end{array}$$

In (12), the functional elements: Dem and Q appear after the nouns and therefore lower in the structure. On the contrary, the DP-hypothesis assumes the functional elements to be higher in the structure to be able to c-command the NP. How then do we account for the ‘deviant’ Igbo structures in (12)?

Kayne (1994) claims that “Heads must always precede their associated complement position, even though in some languages the surface order may be Head-Complement (H-C)

and in some others C-H. In languages with the C-H order, Kayne proposes that the complement undergoes left adjunction to the specifier position. This proposal makes the claim that the universal ordering between a head and its dependents is Specifier-Head-Complement (S-H-C). Kayne (1994) refers to this proposal as the Linear Correspondence Axiom (LCA) represented in (13).

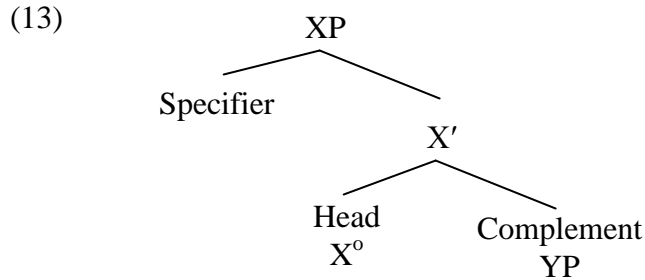

If Kayne's proposal is correct, then structures such as (12) could be analyzed as being headed by a functional head that takes an NP as complement. The NP complement moves to the Spec position in surface syntax giving rise to the C-H order. This is illustrated in (14) below.

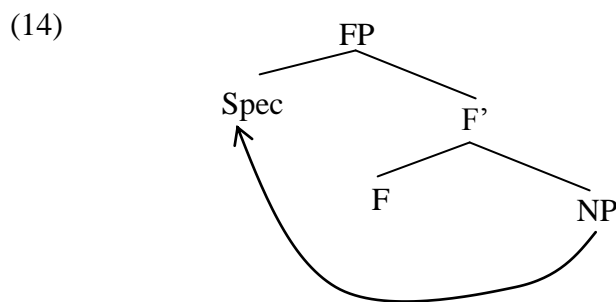

(12a), for example, will have the structure in (15).

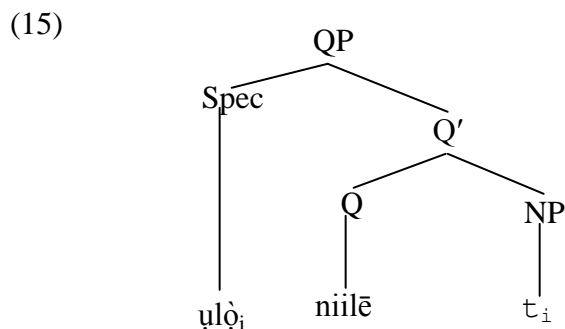

(15) shows that N moves into its surface position where it appears before the quantifier. There are two possibilities. The N head could move to the head of the functional category (head to head movement) or the NP could move to the Spec position of the functional projection. Since Igbo does not show any form of agreement morphology between the noun and the associated functional category, we assume the latter for Igbo as shown in (14) and (15).

We assume that in addition to the projection of a functional category D, which in most cases has zero realization in Igbo (since Igbo lacks an overt determiner), there are other functional heads such as Dem, Q, Gen which the D head c-commands. (12c) could be analyzed as having the structure in (16).

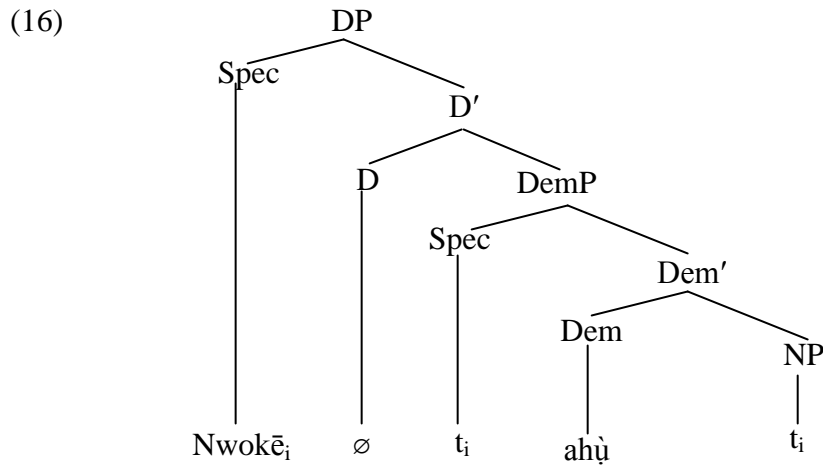

(16) assumes that the NP *nwokē* moves from the complement position, first to Spec DemP and further to Spec DP. In the course of the movement, the NP acquires the features of the functional heads and so could be interpreted as [+ definite + specific].

More than one functional projection could be found within the Igbo nominal phrase, since the functional elements can co-occur. Examine (17) below.

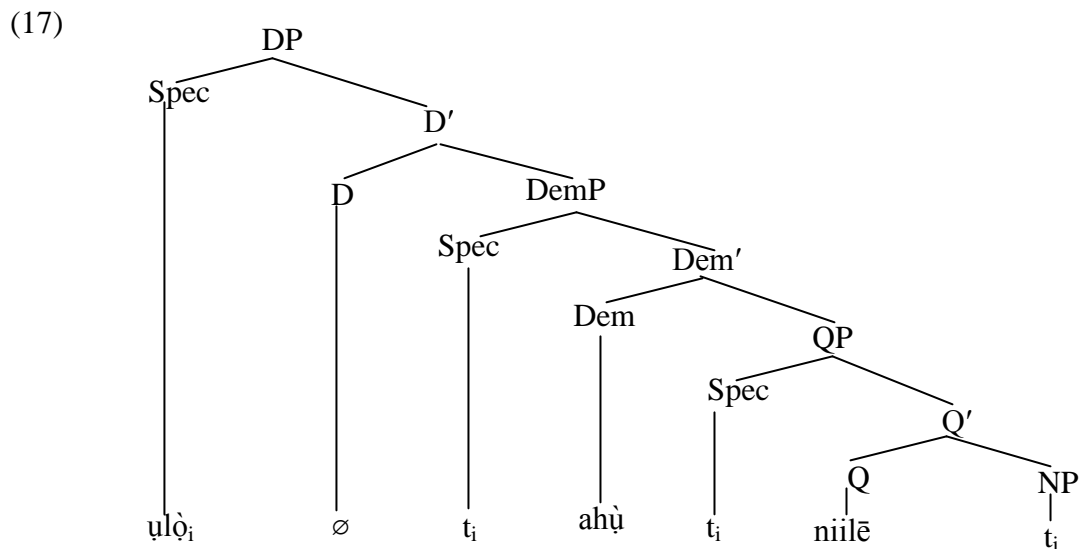

There is no hierarchical order between the DemP and QP. Any of them can dominate the other as shown by the acceptability of both (9a) and (9b) above.

By the movement of the NP to the Spec of the available functional projections, the noun has equal access to the features of the functional heads in a spec-head relationship. For example, the Q *niilē* assigns the feature [+ plural] to the N, while the Dem *ahù* assigns the



features [+ definite + specific]. This could explain why the NP *ulò* could be interpreted as definite and as plural without any overt plural marker.

The question that might arise is, to explain why we assume a separate D head different from Dem and Q in (17). The answer to this question could be given by looking at three issues: the structure of the Igbo genitive phrase, the position of *nkè* in the Igbo nominal phrase and the semantic interpretation of bare nominals.

## 6. The Igbo genitive constructions

Genitive seems to be a cover term for possessive and associative<sup>3</sup> constructions. In Igbo, both the possessive and the associative constructions appear as noun-noun constructions where the second noun modifies the first one.

- (18) a. *akwukwo Ìbè*                          b. *ulò ewū*  
book     Ibe                                  house goat  
'Ibe's book'                                  'goatshed'

(18a) is a genitive construction that involves possession (ownership) where the first noun is the possessum (what is being owned) and the second noun, the possessor (owner). In (18b), the construction is an association between two NPs where the first NP is modified by the second. The distinction between the two types of constructions is sometimes viewed as a distinction between alienable and inalienable possession. Ownership is seen as alienable possession while association is seen as inalienable possession. The two types of constructions have different tone patterns as shown by the (a) and (b) pairs in (19)-(21).

- (19) a. *ul̄ Ò Eḡ*                                      b. *ulò egò*  
house P. name                                  house money  
'Ego's house'                                  'bank'
- (20) a. *isi Ānyā*                                      b. *isi anyā*  
head P. name                                  head eye  
'Anyā's head'                                  'the corner of the eye'
- (21) a. *àlā Īkē*                                      b. *àlà ikē*  
land P. name                                  land strength  
'Ike's land'                                  'hard surface'

The tone patterns observed in (19)-(21) are shown in the table below.

Data No	Inherent tone		Ownership or Alienable Possession (a)	Association or Inalienable possession (b)
	NP1	NP2		
19	H L	H S	H S S S	H L H S
20	H H	H H	H H S S	H H H S
21	L L	H H	L H S S	L L H S

Table 1 *Tone patterns in Igbo genitive constructions*

What is common between the two types of constructions is that a Step tone is found somewhere in the four syllables. In (21), for example, where the NP1 *ala* has a LL tone pattern, the last low has to raise to high to be able to provide the appropriate tonal environment for a downstep. We can then conclude that step tone marks genitive construction in Igbo. We can then posit a Genitive Phrase (GenP) in Igbo and Step Tone (henceforth ST) as its morphological spell-out. The tone patterns in Igbo genitive constructions are predictable following the inherent tone patterns of the NP1 and the NP2<sup>4</sup>. The tone pattern is also influenced by the alienable and inalienable distinction shown above.

The genitive construction establishes a relation between two nouns: the possessor and the possessum. Kayne (1994), Cinque (2003), among others assumes that an abstract head mediates the relationship between the two arguments. In Igbo, the genitive marker, in form of a Step Tone is the mediator between the two arguments and establishes an R-relation between them. The Step tone could be said to occupy the Gen head position while the D head is null. (19a) could be analyzed as in (22).

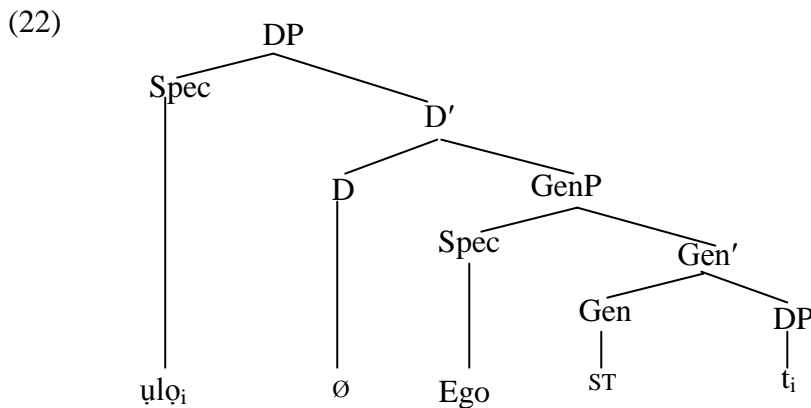

In (22), the ST in the Gen head position links the possessor DP to its possessum DP complement. The movement of the DP possessum to the spec of the higher DP spreads the effect of the ST to the other syllables producing the surface tone patterns observed in (19)-(21). The GenP in (22) has a parallel structure in the verbal genitive shown in (23).

- (23) a. *Egō nwè ul̩*  
 Ego own house  
 'Ego owns the house'

b.

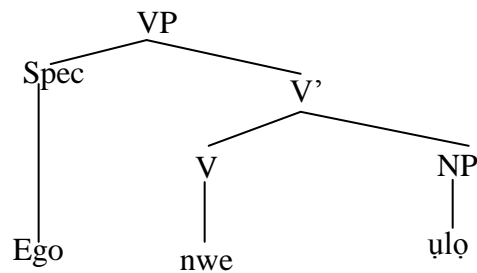

Evidence for the analysis of the possessum DP as having moved from the complement position to the Spec position comes from relative clauses involving possession as in (24) below.

- (24) a. *ulò Egò nwè*  
 house Ego own  
 ‘the house that Ego owns’

b.

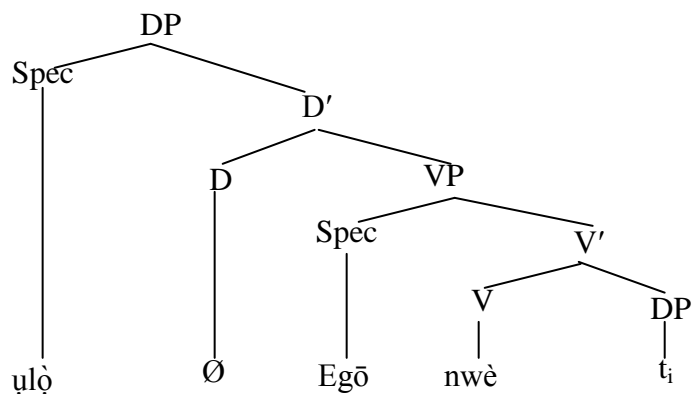

In (24), the VP within the DP lacks a complement, but the complement, is realized in the Spec DP while the D head is null. Genitive in this case is marked by the genitive verb *nwe*. There is no ST and that could explain why *ulò* and *Egò* retained their inherent tone in (24a).

### 7. *Nkè* : An optional D head

Another evidence in support of a different D head from other functional heads in Igbo is the occurrence of *nkè* with virtually all types of nominal modifiers. Consider (25).

- (25) a. *ulò ònke Ego*  
 house ? Ego  
 ‘Ego’s house’
- b. *akwà ònke à*  
 cloth ? Dem  
 ‘this cloth’
- c. *ulò ònke anọ*  
 house ? Nm  
 ‘the fourth house’
- d. *ulò ònke ọcha*  
 house ? white  
 ‘the white house’

What is the function of *̀nke* in the examples above? *̀Nke* seems to function like the definite determiner ‘the’ in English. For example, while *̀ul̩ ̩o̩cha* could be interpreted as ‘white house’ or ‘a white house’, *̀ul̩ ̀nke ̩o̩cha* must be interpreted as ‘the white house’. The same thing is applicable to (25c) where *̀nke* is used with the ordinal numeral. The cardinal and ordinal number is distinguished by tone pattern.

- (26) a. *̀ul̩ ̩ano̩*                                      b. *̀ul̩ ̩ano̩*  
           house four                                      house four  
           ‘four houses’                                    ‘fourth house’

*̀Nke* can occur with the ordinal number as in (25c). When it occurs, it carries with it some note of definiteness and specificity which is implicit with ordinal numbers. The definiteness and specificity features associated with *̀nke* shows that it is a determiner. It can co-occur with other functional heads as shown by (25b) and (25c). (25b) can be analyzed as (27).

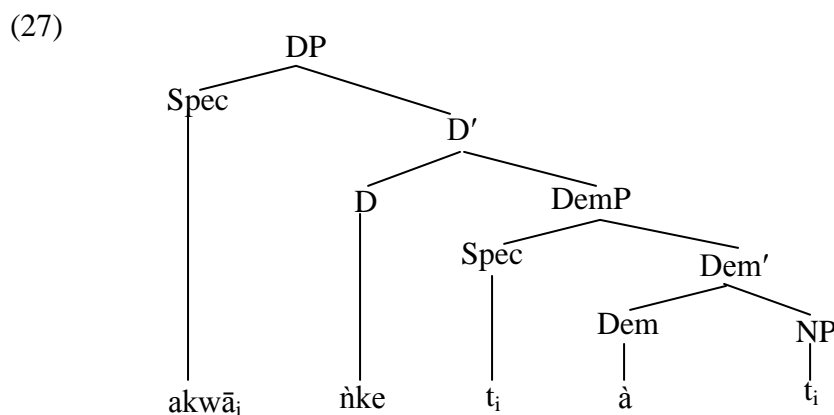

The empty D head position in genitive construction could be occupied by *nke* as shown in (28).

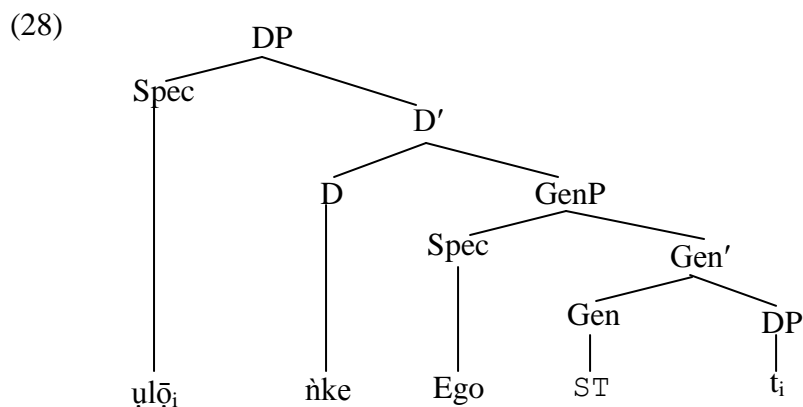

The presence of *nke* in (28) adds some note of specificity to the genitive construction. Structures such as (28), led Mbah (2006) to describe *̀nke* as a possessive marker. It is not actually a possessive marker, since the same genitive tone pattern is observed with or without *̀nke*. *̀Nke* marks definiteness and specificity which are features of a determiner. Another interesting reason why we assume *̀nke* to be a true determiner is that it can be used as a



introduced by *̀ǹk̀e* has no segmental negative marker. The negative marker in the first clause has scope over the second clause. Its negative meaning is derived from the main clause and the negative tone pattern of the subject and verbal element of the subordinate clause (See chapter three 3.4.3.2 for a discussion of negative tone pattern). *Nke* does not introduce affirmative clauses as shown by the unacceptability of (33).

- (33) \**̀U**s**u* *b̀u* *a**n**u* *e**l**u* *̀ǹk̀e* *o* *b̀u* *a**n**u* *à**l**à*  
 bat be animal up C 3S be animal ground

*Nke*, therefore can function as a determiner as well as a negative complementizer. It seems to me that the two are different. They are mere coincidents and therefore one of the many homonyms in the Igbo language. (31b) is therefore analysed as a DP where *̀ǹk̀e* occupies the D head position.

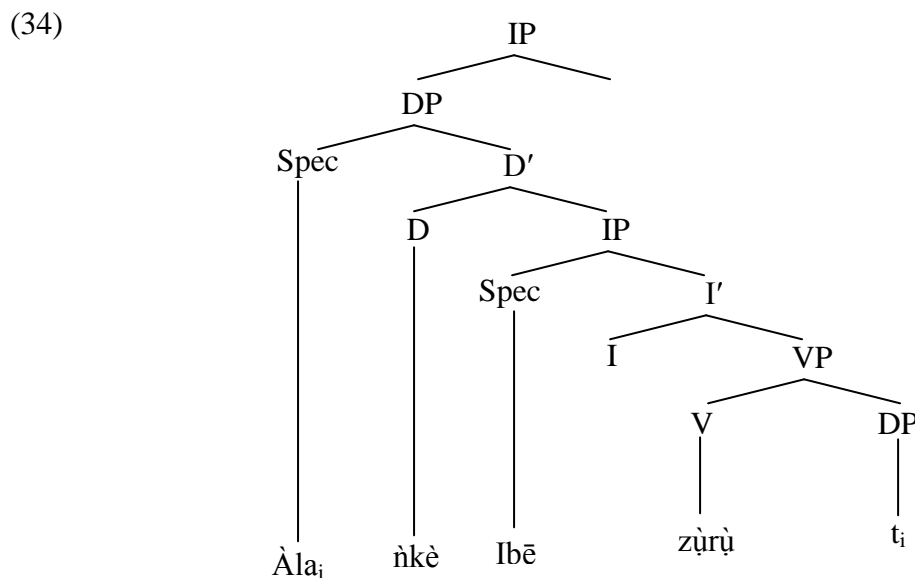

(34) is an object relative clause, i.e. a relative clause where the object is missing in its base generated position. A subject relative clause such as 31c will have the structure below.

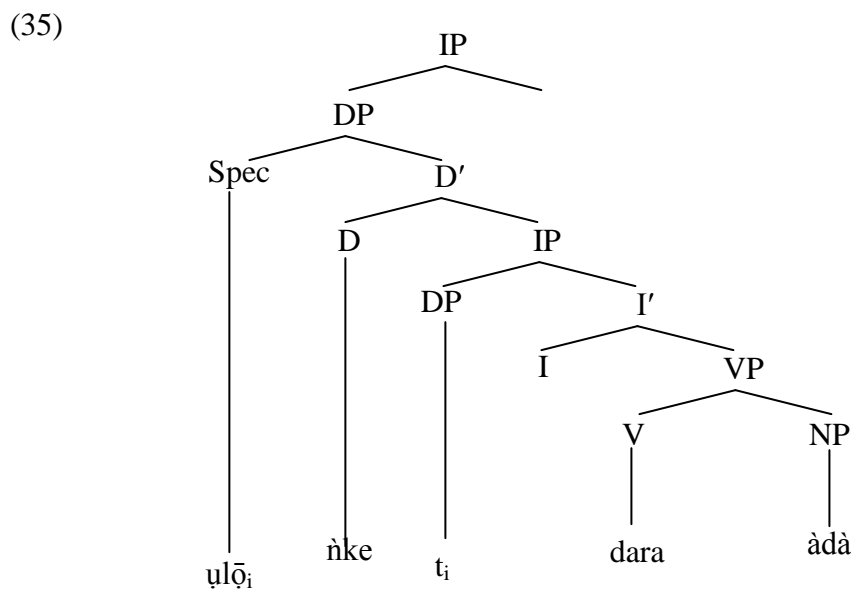



(39) Japanese (adapted from Fukui 1995: 105)

- a. *John-ga hon-o yonda*  
 John-NOM book-ACC read  
 ‘John read a book’
- b. *Inu-ga heya-ni haitte-kita*  
 dog-NOM room-to in come-PAST  
 ‘The dog entered the room’

Bare nominals can be interpreted as definite, indefinite or generic which are features associated with the functional category D. This leads to the conclusion that in such languages including Igbo where there are bare nominals, there is an associated null D head which carries the D-features. For example, *atūrū* in (36a) will have the structure (40).

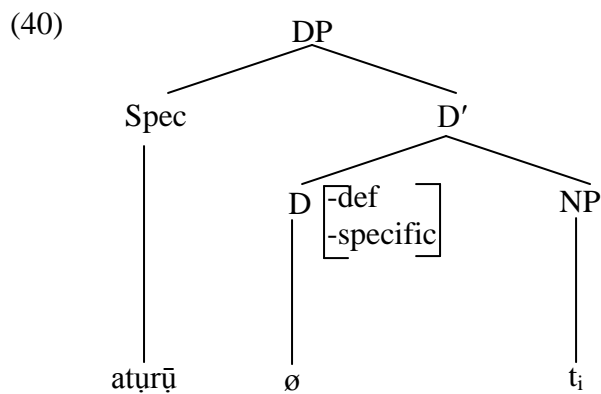

## 9. Conclusion

This paper has tried to examine most of the elements that could be found within the Igbo nominal phrase. In line with the DP-hypothesis which assumes that a nominal phrase is headed by a functional element D, and the assumption that only elements that behave like articles are qualified to occupy the D head position, we conclude that Igbo does not have overt determiners like we have in English. Rather, Igbo has null D head. Evidence for the null head comes from the structure of genitival constructions involving noun-noun constructions that lack overt relational item. The tonal melody triggered by a Step Tone which is generated under Gen head and links NP1 to NP2. The NP1 which occupies the spec of DP originates from the complement of Gen position. The second evidence for the null D head is the construal of bare nouns as either definite, indefinite or generic which are features associated with D. *Nkè* seems to be the only overt elements that can occupy the D head position in the Igbo nominal phrase.



## Notes

- 1 It is not clear why Emenanjo prefers to refer to the structure as simple since the schema contains also a relative clause.
- 2 This structure might sound a bit odd for some Igbo speakers because of the premodifying adjective *ajō* which has a postmodifying alternative *ojoō*. We only use the structure to show how Emenanjo's schema can be instantiated.
- 3 Associative constructions are sometimes treated as nominal compounds.
- 4 For details of these tone patterns, see Nwachukwu (1995).
- 5 It appears that the English demonstratives are combinations of the definite article 'the' and category Dem which are spelt-out as 'this', 'that', 'these', 'those'. They have phono-semantic resemblance with 'the'. That could explain why the demonstratives implicitly express the feature [+definite] and also explains why the demonstratives and 'the' cannot co-occur in English. Igbo seems different in allowing the definite determiner *̀̀kè* to co-occur with the demonstratives.

## References:

- ABNEY, Steven 1987. The English noun phrase in its sentential aspect. Doctoral dissertation, Massachusetts Institute of Technology, Cambridge, MA, 1987.
- ADGER, David. 2003. *Core syntax*. Oxford: Oxford University Press, 2003.
- AJÍBÓYÈ, Oládíipò .2007. *The syntax and semantics of Yoruba nominal expressions*. Port Harcourt, Nigeria: M & J Grand Orbit Communications, 2007.
- CHOMSKY, Noam. 1995. *The minimalist program*. Cambridge, Mass: MIT Press, 1995.
- CINQUE, Guglielmo. 2003. The Pronominal origin of relative clauses. Ms. University of Venice, 2003.
- EMENANJO, Nolue. 1978. *Elements of modern Igbo grammar*. Ibadan: Oxford University Press, 1978.
- FUKUI, Naoki. 1995. The principles and parameters approach: A comparative syntax of English and Japanese. In SHIBATANI, M. and BYNON T. *Approaches to language typology*. Oxford: Oxford University Press, 1995, pp. 327-372.
- GUSTI, Giuliana. 1992. Heads and modifiers among determiners: Evidence from Romanian and German. *University of Venice Working Papers in Linguistics 2(4)*, 1992, pp. 1-19.
- KAYNE, Richard. 1994. *The antisymmetry of syntax*. Cambridge, Mass: MIT Press, 1994.
- LONGOBARDI, Giuseppe. 2004. The structure of DPs: Some principles, parameters, and problems. In BALTIN, Mark, and COLLINS Chris. *The Handbook of contemporary syntax theory*, New York: Blackwell Publisher. 2004, pp. 562-603

- MATTHEWSON, Lisa. 1998. *Determiner systems and quantificational strategies: Evidence from Salish*. The Hague: Holland Academic Graphics, 1998.
- MBAH, B. M. 2006. *GB syntax: Theory and application to Igbo*. Enugu: Association of Nigerian Authors, 2006.
- NWACHUKWU, P. Akujūobi. 1995. *Tone in Igbo syntax*. Nsukka: Igbo Language Association Publications, 1995.
- OLUIKPE, Benson. 1979. *English in Igboland*. Onitsha: Africana Publisher Limited, 1979.
- PROGOVAC, Lyjiljana. 1995. Determiner phrase in a language without determiners. *University of Venice Working Papers in Linguistics*. 5(2), 1995.
- RADFORD, Andrew. 1997. *Syntax: A minimalist introduction*. Cambridge: Cambridge University Press, 1997.
- RADFORD, Andrew. 2004. *Minimalist syntax: Exploring the structure of English*. Cambridge: Cambridge University Press, 2004.
- STOWELL, Timothy. 1981. Origins of phrase structure. Doctoral Dissertation, MIT Cambridge, MA, 1981.
- SZABOLCSI, Anna. 1987. Functional categories in the noun phrase. In KENESEI, I. *Approaches to Hungarian 2*. Szeged, 1987.
- UWALAKA, Mary-Angela. 1991. Wh-Movement in Igbo. *UCL Working Papers in Linguistics 3*. 1991

Greg Orji Obiamalu  
 Dept of Linguistics,  
 Nnamdi Azikiwe University, Awka,  
 Nigeria  
 gregobiamalu@yahoo.com